

ES-210

The image features a minimalist design with a white background. In the center, the text "ES-210" is displayed in a clean, black, sans-serif font. The lower portion of the image is dominated by large, overlapping geometric shapes. A large, dark gray triangle points upwards from the bottom right corner. A lighter gray triangle points downwards from the top left corner. These two triangles overlap in the center-bottom area, creating a darker gray intersection. The overall composition is balanced and modern.

欢迎使用

PENTAIR
PENTAIR

PENTAIR() EVERPURE()

目录

1. 安全提示
2. 开箱检查
3. 产品介绍
3.1	
3.2	
3.3	
3.4	
4. 安装说明	
4.1	
4.2	
4.3	
4.4	
5. 使用说明	
5.1	
5.2	
5.3	
5.4	
5.5	
6. 保修服务	
6.1	
6.2	

1. 安全提示

-

-

-

-

-

- 100%

-

0

-

-

-

-

-

-

- 2-49

-

2. 开箱检查

- 1.
- 2.
- 3.
- 4.
- 5.
- 6.

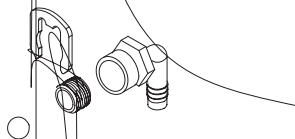

3. 产品介绍

3.1 产品用途

— 2001

3.2 原理图

3.2.1

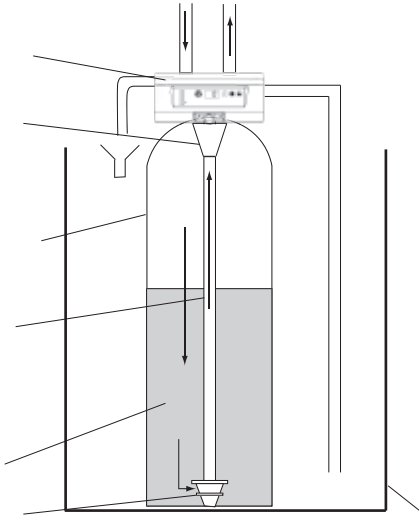

3.2.2

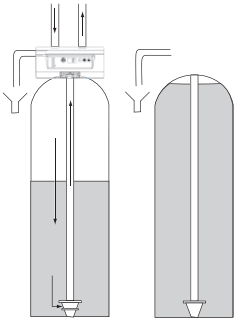

3.2.3

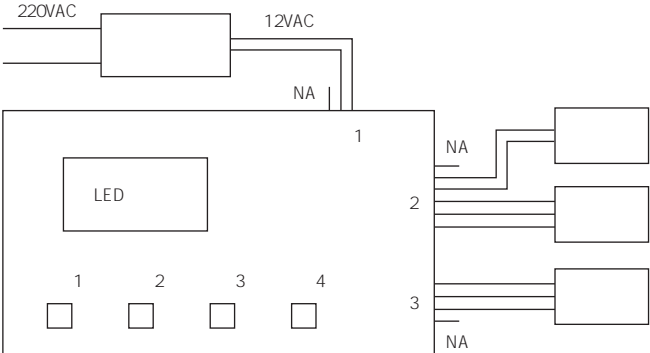

3.3 技术参数

	ES-210
/	3/4" (25mm)BSPT
	0.14 0.35MPa
	0.9m ³ /h
	1.5m ³
	8000m ³
	2001
	12L
	10kg
	220V-50Hz
	8W
	4 38
	2 49
* *	500*280*510mm
	1/2" (12.7mm)
	3/8" (9.5mm)

3.4 主要成分或部件

		/			
1		0.6-0.8mm		12L	10
2		250mm 400mm		1	10
3		25L		1	10
4		222mm × 222mm × 119mm	+	1	10
5		25mm	PVC	1	10
6		25	ABS	1	10
7		25	ABS	1	10

4. 安装说明

4.1 安装注意事项

•

•

- a). 55cm × 30cm
- b). 66cm
- c). 40-160cm

d). 10.2cm

e). / 220V-50Hz

f). 8W

g). 2m

h).

j). 4°C 38°C

k). 0.14MPa 0.35MPa

•

2°C 49°C

•

•

40-160cm

10cm

•

•

0.14 0.35MPa

•

•

•

•

10

•

Y

•

6m

•

4.2 安装准备

工具准备:

4.3 安装示意图

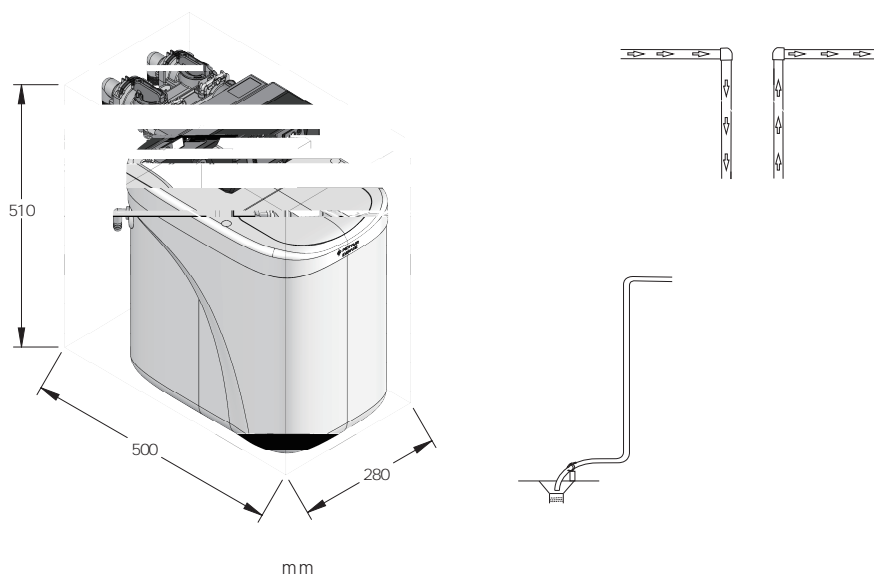

4.4 安装步骤

4.4.1

接入接头前注意：

- 0
- 100% 0

需移除卡夹时：

-
-
-

4.4.2

-
-
-
-
-
-

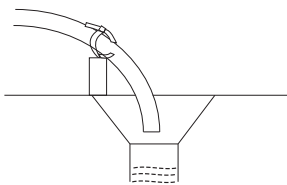

4.4.3

- 1/2"
-



4.4.4

5

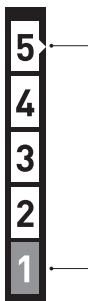

5. 使用说明

5.1 调试及设置

5.1.1

5.1.2

0

0.20

1.0

3.0

5.1.3

2 00)

Ⓢ

3

--

5.1.4

Ⓢ

3

1.

" C1"

2.

Ⓢ

3.

" C2"

4.

2 3

3

5.1.5

4

- 1. 3
- 2. " u"
- 3.
- 4. 5

- 1. 3 " 0"
- 2. " u"
- 3. " u0"
- 4. 5 1
- 5. 1-4

u1	
u2	
u3	
u4	
u0	

5.1.6





3

- 0=
- 0.3= 8
- 0.5= 12
- 1-30=

5.1.7

- Err3
- u1 0.6kg

ES-210	
ppm	T
50	8.00
100	4.00
150	2.67
200	2.00
250	1.60
300	1.33
350	1.14
400	1.00
450	0.89
500	0.80
550	0.73
600	0.67
650	0.62
700	0.57
750	0.53
800	0.50
kg	0.6

- 4-5L
- " "
-  3 [] C1 1/4
- ,
-   C2
-  

C7

①

5.1.8

/

5.2 使用方法

" "

<0.3mg/L

<3NTU

0.14MPa

0.6MPa

220V-50Hz

8

8

8

1.5



3

30



4



5



H2

H1		
H2		/
H3		
H4	200	9,999 65,535
H5		
A0	0	
A1	1	
A2	2	
A3	3	
A4	4	
A5	5	
A6	6	

-

-

-

5.5 故障诊断及排除

	#4	
	#4	
	0	0
		20psi 1.3bar

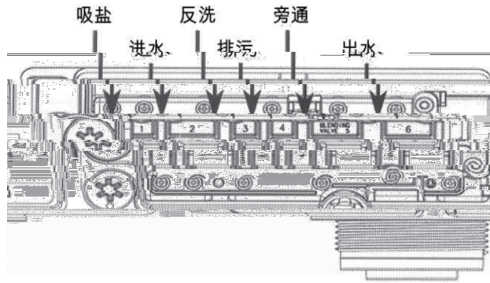

Err 1		Err 1
Err 3	Err 3	1. 2.
	5	1. 2.

6. 保修服务

6.1 保修卡



保 修 卡

1

1

2

3

4

-
-
-
-
-
-
-

5

6

7

8

800-820-6671

400-820-6671

09:00-19:00

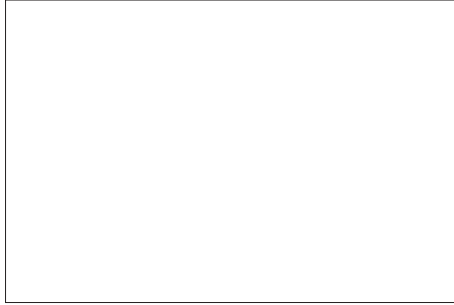

371

215011

800-820-6671

400-820-6671

www.pentairwater.cn

MPMA003_A